



ZR6FD Jubilee logo!

drukwerk papier / paper
printing ZS6KO
ZS6BAQ ZS6PVW familie

WATTS

07 - 2005

Year 75+7m

Monthly newsletter of the Pretoria Amateur Radio Club
Maandelikse nuusbrieff van die Pretoria Amateur Radio Klub.

✉ PARC, PO Box 73696 Lynnwood Ridge 0040, RSA

web <http://www.qsl.net/zs6pta>

Bulletins : 145,725MHz 08:45 Sundays / Sondag
Relays : 1840, 3700, 7066, 10135, 14,200 MHz
depending on season

Swapshop: After bulletin 2m and 40m (also on-line)

Kid's Day 16 June

PARC at Clapham High School

Kinderdag 16 Junie



Johan, Sander en Pierre doen voorbereiding. Craig and Richard were also there. Two kids were particularly interested, being a boy Gerard and girl Nqobile (shown above) intently listening to the goings-on. Nqobile got a chance to ask Mark Shuttleworth a question.

In this issue

- Editorial
- Club history
- Minutes of Meeting- Jun '05 -Notule van Vergadering
- Member news and diary
- Snippets
- Technical
- Page eight

in hierdie uitgawe

- Redaksioneel
- Klubgeskiedenis
- Ledenuus en dagboek
- Brokkies
- Tegnies
- Bladsy agt

Next Meeting

Date: 14-07-2005
Time: 19:30 for 20:00
PARC Clubhouse,
South Campus,
University of Pretoria.
SE cnr University and
Lynnwood roads.

Management team / Bestuurspan Aug 2004- Aug 2005:

Chairman, SARL liason, WATTS newsletter	Hans Kappetijn	ZS6KR	hans@grv.co.za	012-333-2612 072-204-3991
Vice Chairman, P.R., Fleamarket, RAE, Projects	Almero Dupisani	ZR6RY	almero.dupisani@up.ac.za	012-567-3722 082-908-3359
Sekretaris, Tydrenne, Jakkalsjag	Johan de Bruyn	ZR6JHB	johandbr@absa.co.za	012-803-7385 082-492-3689
Treasurer, Clubhouse, Database	Richard Peer	ZR6CK	peerrk@safrica.com	012-333-0612 082-651-6556
Webmaster, Projects	Sander Wissing	ZR6SW	zr6sw@qsl.net	012-661-4853 083-607-4549
Awards, Historian	Tjerk Lammers	ZS6P	zs6p@iafrica.com	012-809-0006

Co-opted / Geko-opteer:

Auditeur	Egbert Begeman	ZS6AZG	begeme@unisa.ac.za	012-347-1905
Tydrenne	Johann de Beer	ZR6YV		011-918-1060
Morse testing	Bill Ingleson	ZS6KO		012-331-2327
Tegnies	Johan Lehmann	ZR6ANF	jlehmann@csir.co.za	083-300-8677
Repeater Custodian	Hans Gurtel	ZR6HVG	adele123@absamail.co.za	082-940-0623
Repeater Maintenance	Willie du Plessis	ZS6AEA	hesterdup@webmail.co.za	012-565-5555
Klubfasiliteite,	Willie Greyling	ZR6WGR	willie@up.ac.za	082-940-2490 083-653-2101

Editorial

Being an Editor is no mean job if useful publishable material has to be sucked out of his personal resources or old magazines. Fortunately your Editor happens to have a technical background and has been lucky to conjure up something suitable on a monthly basis. It would be nice to also receive something from you, the reader, who surely must be proud of something you have done in the hobby.

Why not publish that in WATTS? Others can gain knowledge from your project. The ARRL Handbook is full of projects of individuals that they published over the years in monthly publications.

Send a short story and/or a picture to your Editor. Shack pictures, tower and antenna designs, an electronic project or bragshot of your mobile installation. Let others see what you do in the hobby.

This also applies to activities such as rallies, foxhunting etc. If you want exposure or promote interest, sell your activity with timely information and an occasional interesting post-event report and/or snapshot of the event.

The Editor is not a Reporter; news items and other publishable material must ideally be forwarded by you, the member, or interest group.

Apart from a small group, members seem to be invisible beings with radio voices, probably too modest to be in the public eye (except at flea markets), and not consider it necessary to document anything for posterity. If you think you have something useful, even if not in the right format, let me have it, and I will endeavour to make something publishable out of it.

Redaksioneel

Om 'n Redakteur te wees is nie 'n maklike werk nie as nuttige publiseerbare material uit sy eie persoonlike bronne of ou tydskrifte gesuig moet word. Gelukkig het u Redakteur 'n tegniese agtergrond en is en dus gelukkig genoeg om iets pasliks te kan op toor op 'n maandelikse basis. Dit sal egter lekker wees om iets te ontvang van jou, die leser, wat tog seker wel trots was op iets wat jy in die verlede gedoen het in die stokperdjie.

Waarom kan dit nie in WATTS gepubliseer word nie? Ander kan kennis uit jou projek put. Die ARRL se *Handbook* is vol met projekte van individue wat hulle self in maandblaai gepubliseer het.

Stuur 'n kort storie en/of 'n foto na u Redakteur. Radio-kamer fotos, toring- en antenna ontwerpe, 'n elektroniese projek of spogfoto van jou mobiele installasie. Laat ander ook sien wat jy in die stokperdjie doen.

Dit geld ook vir aktiwiteite soos tydrenne, jakkalsjag ens. As jy blootstelling wil hê of belangstelling wil aanwakker, verkoop dan jou aktiwiteit met in-tydse informasie en by geleentheid 'n interessante verslag en/of kiekie van die gebeurtenis.

Die Redakteur is nie 'n Verslaggewer nie; nuus items en ander publiseerbare materiaal moet ideaal-gesproke van jou, die lid, of belangegroep kom.

Behalwe 'n klein groep, blyk lede onsigbare wesens te wees met radio-stemme, wat te beskeie is om in die publieke oog te wil wees (behalwe by vlooiemarkte), en dit nie nodig ag om iets te dokumenteer vir die nageslag. As jy dink dat jy iets nuttigs het, al is dit nie in die regte vorm nie, laat ek dit kry en ek sal dit probeer regtimmer om dit publiseerbaar te maak.

Minutes of the monthly club meeting of the Pretoria Amateur Radio Club held at the South Campus of the University of Pretoria on 9 June 2005

Welcome: Hans ZS6KR declared the meeting open and welcomed all who attended.

Attendance: The meeting was attended by 22 members and two visitors Marelise Holtzhausen and Juanita Grobler. Apologies were received from Johan ZR6JHB, Almero ZR6RY, Joe ZS6TB, Craig ZR6REV, Molly ZR6MOL, Edwin ZR6ESP, Hilary ZR6HAP, Bill ZS6KO

Personal Matters/Lief en leed: none noted /geen aangeteken nie

Matters arising from previous minutes: None.

Minutes of previous meeting: The minutes of the previous meeting as published in Watts were approved. Proposed by Alf ZR6ABA and seconded by Willie ZR6WGR.

Club Activities

Rallies/Tydrenne: Die Sasol Nasionale Tydren vind vanaf more plaas. Verskeie van ons lede is alreeds vanaand vertrek en kan nie hier wees nie.

DF Hunt/Jakkalsjag: Vanweë die afwesigheid van verskeie deelnemers word dit tot volgende maand uitgestel.

Social/Sosiaal: Nnthing planned during the winter.

Finance Report/Finansiele verslag: Richard ZR6CK reported that the club's current account to be close zero after the celebration expenses. Subs payments are now due and should make some liquidity.

Projects/Projekte: Hans ZS6KR briefly showed a radio protection scheme involving a Marchwood-style circuit breaker that could be added to any DC power supply to cut out as soon as its output=the radio experiences overvoltage. Such a fault condition can occur when the series-regulator pass-transistors fail. A limited number of kits were available to members present and many more are in the making..

Repeaters/Herhalers:

1. The interfering 70cm DTMF tones were eliminated by Johan ZR6ANF after he returned from overseas.

2. Pine ZS6OB reported that the 2m repeater now has better all-round coverage despite using a (new) 2-stack. He also appealed for members to make themselves available as extra hands for physical work whenever the need arises in future repeater-site upgrade work. He needs to have a list of volunteers that can be called on when necessary.

Fleamarket/Vlooiemark: Early September was suggested in the committee.

Ham Diary/Dagboek: The meeting was informed of local, national and international happenings up to middle June.

General/Algemeen:

1. Victor ZS6VG presented a Portugal Day commemorative medal to Hans ZS6KR and Bill ZS6KO (in absentia). Both operated the field station at the Portuguese Club grounds and spent some time observing the festive activities on the weekend of 10-11 June. They were also invited to a gala dinner on Friday evening 16 June.

2. Pine ZS6OB mentioned a financial offer by non-amateur interests for the rental of space on our 2m tower for two 5GHz dishes. Tjerk ZS6P gave reasons why we should not do this as our gratis tenure was a paperless historical agreement.

Presentation/Aanbieding : A CD film on the ARRL HQ was shown as well as two more Icom Radio News films about Dayton 2004 and Field Days.

Next meeting.Volgende vergadering: 14/07/2005.

Closing/Sluiting: Die vergadering het om 21:00 gesluit. Dankie aan Marelise vir die aanbied van verversings. ZS6KR

Radiokamer Nuus

Paul (Doppies) ZS6BAQ het nou onlangs 'n paar veranderings in sy radiokamer (hok) aangebring en apparaat drasties herrangskik. Die brug op die tafel het hy gou self gemaak.

Een van sy assistente neem nou 'n ruskansie waar op die baas se stoel.

Het julle ook (hok) fotos? Kom ons publiseer hulle in WATTS.

Do you also have shack photos? Let's publish them in WATTS.



Birthdays

Verjaarsdae

Julie



02 Peter ZS6RX
05 Lynette, daughter of Bill ZS6KO
06 Helen ZS6-2507, daughter of Roy ZS6XN
11 Peter ZR6FD
13 PieterZR6AHT
17 Lynn, lv van Andre ZS6BRC
17 Pine ZS6OB
19 Sarina, lv van Willie ZR6WGR
20 Roy ZS6XN
21 Elmarie ZR6AXF lv van Johan ZR6ANF
22 Rozanne, dogter van Tjerk ZS6P
24 Brittany, dogter van Louis ZR6LVW
25 Justin, ZS6-262, son of Errol ZR6VDR

July

Anniversaries Herdenkings

04 Beatriz and Manny ZS6AKX ()
06 Julie and Paul ZS6BMF (42)
15 Ellen en Joe ZS6AIC ()
23 Pamela and Harry ZS6HRD (51)
23 Lorraine and Stan ZS6SDZ (52)
28 Pat ZR6AVC and Frank ZS6GE (21)

26 Frank ZS6GE
27 Rachel ZR6RDB
27 Julie, sw of Paul ZS6BMF

Condolences

to Lynn, sw of Andre ZS6BRC who lost her mother.
to Bernie ZS6ANU who lost a dear friend.

Sick Parade | Krukkelys

Selma, sw of Joe ZS6TB spent a few days in hospital
Viv ZS6BZS was also in hospital a while and is now recuperating

PARC Diary | Dagboek

July 01 RAC Canada Day Contest 0000-2359
01-03 PEARS mid-year digital contest
02-03 Venuezuelan Ind. Day Contest 0000-2359
03 DARC 10m Digital Contest 1100-1700
09-10 IARU HF World Championship 1200-1200
24 Boland ARC 40m Contest
14 PARC club meeting

Forgot?

**Please renew your membership that was due
on June 30.
R50 to FNB Account 546 000 426 73
FNB Branch Lynnwood 25 20 45**

Snippets | Brokkies

- Egbert ZS6AZG wil graag 'n Satelliet Werkgroep begin. Kontak hom by egbert@worldonline.co.za of 012-347-1905 of 082-490-1963
- The next Rally is the HMC event in Witbank. Contact Johan ZR6JHB for this one.
- Johan ZS6JPL (ex ZR6ANF) was seker die eerste om 'n ZS roepsein te bekom onder die nuwe regulasies.

NOTICE OF ANNUAL GENERAL MEETING. The Pretoria Amateur Radio Club hereby wishes to inform members and interested parties that its 75th AGM will be held at the Clubhouse premises 8pm Thursday 11 August 2005.

KENNISGEWING VAN ALGEMENE JAARVERGADERING. Die Pretoria Amateur Radio Klub gee hiermee kennis aan alle lede en belangstellende partye dat sy 75e AJV by die Klubhuis op Donderdag 8nm 11 Augustus 2005 gehou sal word.

CALL FOR MOTIONS | AANVRAAG VIR MOSIES

**75th AGM Motions can be submitted by the next Club meeting 14 July or 21 July latest.
75^e AJV Mosies kan by die volgende Klubvergadering 14 Julie voorgelê word of laastens op 21 Julie.**

**!! Only paid-up members may nominate and vote at the AGM. Forms will be in our Aug. issue.
!! Slegs opbetaalde lede mag by die AJV nomineer en stem. Vorms sal in ons Aug. uitgawe wees.**

Satellite Information

received from Egbert Z6AZG

AMSAT SATELLITE STATUS DEFINITIONS

Operational	- the satellite achieves its primary mission most of the time
Semi-Operational	- the primary mission is achieved at some times
Non-Operational	- the primary mission is not achieved
Future Launch	- the satellite has a scheduled launch date

OSCAR Satellite Status Summary 10 May, 2005

AO-51 (Echo)	Check Schedule
VO-52 Hamsat)	Operational
AO-7	Sunlit Ops Only
UO-11	
RS-15	Intermittent
AO-16	Digipeating
LO-19	CW Beacon Only
AO-27	Recovery Mode
FO-29	
GO-32	
SO-41	Erratic
NO-44	Low Batteries
MO-46	Reported Dead
SO-50	
ARISS	
RS-22	
SSETI Express	May 2005
P3-E Express	
PCSat2	

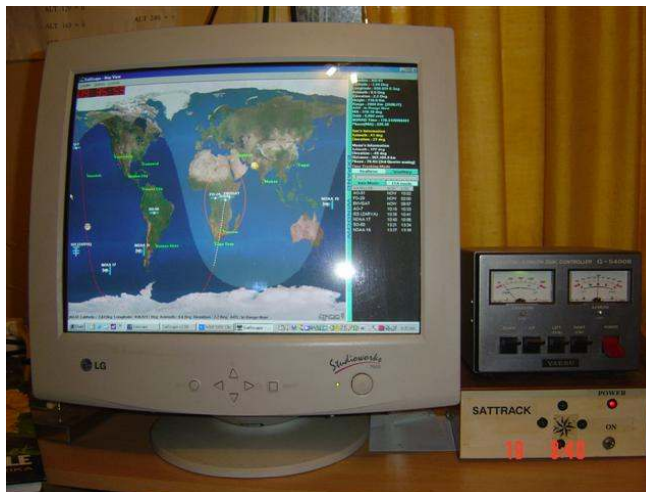

Egbert tracking a satellite

OPERATIONAL SUMMARY

Here is a basic summary of satellite status. The table that follows this status is a summary of operational satellites that are or were recently popular. These tables list only OSCAR satellites.

Operational	AO-51, AO-27, FO-29, GO-32, SO-41, SO-50, ARISS
Semi-Operational*	AO-7, UO-11, RS-15, AO-16, LO-19, SO-41, NO-44
Non-Operational	OSCAR, OSCAR II, OSCAR III, OSCAR-IV, AO-5, AO-6, AO-8, RS-1, RS-2, AO-10, FO-12, RS-10/11, UO-14, UO-15, DO-17, WO-18, FO-20, AO-21 (RS-14), RS 12/13, UO-22, KO-23, AO-24, KO-25, IO-26, PO-28, MO-30, TM-31, RS-17, PO-33, PO-34, SO-35, UO-36, AO-37, OO-38, WO-39, AO-40, SO-42, SO-43, NO-45, MO-46, BO-47, BO-48, AO-49

AMSAT-OSCAR 51 (Echo or AO-51) Launched June 29, 2004. Status: Operational

Analog Uplink:	145.920 MHz FM (PL - 67Hz) 145.880 MHz FM QRP (no PL) 1268.700 MHz FM (PL - 67Hz)
Analog Downlink:	435.300 MHz FM 2401.200 MHz FM
PSK-31 Uplink	28.140 MHz USB
Digital Uplink:	145.860 MHz 9600 bps, AX.25 1268.700 MHz 9600 bps AX.25
Digital Downlink:	435.150 MHz 9600 bps, AX.25 2401.200 MHz 38,400 bps, AX.25
Broadcast Callsign:	PECHO-11
BBS Callsign:	PECHO-12

OSCAR 51 or Echo as it is more commonly known is a FM satellite carrying 4 VHF receivers, 2 UHF transmitters, a multimode receiver and a 2400MHz transmitter. It can handle voice and FSK data up to 76.8Kbps. Echo was launched into a low, sun-synchronous polar orbit approximately 850 km high. You must transmit a 67Hz PL tone in order to access the Echo voice repeater.

VUSat-OSCAR 52 (HamSat or VUSat) Launched Q2 2005. Status: Operational

Uplink	435.220-435.280 MHz LSB/CW
Downlink	145.870-145.930 MHz USB/CW (Inverting)
Beacon	145.936 Unmodulated Carrier 145.860 Telemetry

HamSat was constructed by AMSAT India and ISRO. It carries two 1watt linear transponders, and an FM beacon. HamSat was launched aboard the PSLV-C6 launched at 4:45z on May 5 2005. After launch, the primary payload (CartoSat) was deployed, followed 40 seconds later by HamSat. Both the satellites have been placed in polar sun-synchronous orbit (SSO) at an altitude of 632 x 621 km with an inclination of 97.8 deg with respect to the equator.

Fuji OSCAR 29 (FO-29) Launched 17 August 1996. Status: Operational

Analog Uplink	146.000 to 145.900 MHz CW/LSB
Analog downlink	435.800 to 435.900 MHz CW/USB
Beacon	435.795 MHz (normally CW telemetry)
Digital Uplink	145.850, 145.870, 145.910 MHz FM
Digital Downlink	435.910 MHz 1200 baud BPSK or 9600 baud FSK
Digitalker	435.910 MHz FM

Please send the reception reports to lab2@jarl.or.jp . Please use the subject line: 'FO-29reception report'.

Mineo, JE9PEL, has an FO-29 satellite telemetry analysis program that will automatically analyze all digital telemetry from the satellite (such as current, voltage and temperature). FO29CWTE is available at: <http://www.ne.jp/asahi/hamradio/je9pel/>

Saudi-OSCAR 50/SaudiSat 1C (SO-50) Launched 20 December 2002. Status: Operational

Uplink 145.850 MHz FM
Downlink 436.795 MHz FM

SO-50 carries several experiments, including a mode J FM amateur repeater experiment operating on 145.850 MHz uplink and 436.800 MHz downlink. SO-50 is operational for 10 minutes when turned on by the following procedure:

- 1) Transmit for 1-2 seconds on 145.850 MHz with a tone of 74.4 Hz to arm the 10 minute timer on board the spacecraft.
- 2) Next transmit on 145.850 MHz (FM Voice) using 67.0 Hz to key the repeater on and off within the 10 Minute window.

Note: Sending the 74.4 tone again within the 10 minute window will reset the 10 minute timer.

Amateur Radio on the International Space Station (ARISS) Status: Operational

Region 1 2m uplink 145.200 MHz FM
Regions 2 & 3 2m uplink 144.490 MHz FM
Cross Band Repeat Uplink 437.800 MHz FM
Worldwide downlink (All modes) 145.800 MHz FM
Worldwide Packet uplink 145.990 MHz FM
US Voice Callsign NA1SS
Russian Voice Callsigns RS0ISS, RZ3DZR
UI Digipeater Callsign ARISS
Bulletin Board Callsign RS0ISS-11

The current Expedition 10 crew is: Commander Leroy Chiao, KE5BRW, Flight Engineer Salizhan Sharipov

The ISS system has sometimes been turned on to Cross Band Repeat mode. In this mode it functions as a Mode B-FM repeater. Amateurs in the US and elsewhere have reported using the repeater with home stations and handheld radios with great success. The crew is also able to use the radio to transmit even when the system is in this mode.

While the system is in cross band repeat mode the packet system is turned off and vice-versa. The ISS daily crew schedule can be found at <http://spaceflight.nasa.gov/station/timelines/>. Remember that the crew operates on UTC time. Also, all of the time line is NOT translated from Russian and posted. Current ARISS News is available at the ARISS page in this website.

Additional information is available at: <http://www.rac.ca/ariss/>

RS-22 (Mozhayets 4) Launched 27 September 2003. Status: Operational

Beacons 435.352 CW, FM, 145.840 CW, FM

RS-22 a training satellite built by the Mozhaisky military academy in St. Petersburg, Russia. It was launched into a 680km circular orbit inclined to 98.2 degrees. It carries a CW beacon on 70cm that sends telemetry in the form of 16 groups of 5 to 7 characters framed by "rs22". Code is sent at ~5wpm with about 10 seconds between each group.

SSETI Express Status: Future Launch July 2005

Voice Uplink 437.250 FM 67Hz CTCSS
Voice Downlink 2401.840 FM
Packet Up/Downlink 437.250 9k6 packet
Packet Downlink 2401.840 38k4 packet

SSETI Express is nearing completion at the ESA technical centre in the Netherlands. Data modes will be primarily used for down linking telemetry and data from the satellites experiments. ESA will be providing telemetry capture software for amateurs to use and will be offering a prize to the amateur station who provides them with the most telemetry after launch. The mode U/S FM voice transponder will require 67Hz tone access in a similar way to AO51 and will provide three channels of 256 bit telemetry encoded as DTMF tone bursts. S Band output is 3 Watts to 3 x 8dBic RHCP patch antennas. Latest information including integration photos and a webcam in the cleanroom is at <http://www.sseti.net> - click on "missions" and then "express".

AMSAT-Phase 3E Status: Future Launch 2005-2006.

Band	Analog Uplinks	Analog Downlinks
10m	29.500 +/- 5 kHz	
2m	145.845 - 145.945	145.837 - 145.837
70cm	436.050 - 436.150	436.200 - 436.350
23cm (1)	1268.600 - 1268.750	1268.775 - 1268.925
23 cm (2)	1260.100 - 1260.250	1260.275 - 1260.425
13 cm (1)	2400.275 - 2400.425	2400.600 - 2401.000
13 cm (2)		
6 cm	5668.600 +/- 25 kHz	
X-Band		
K-Band	24048.300 +/- 25 kHz	
R-Band	47088.300 +/- 25 kHz	

AMSAT-Phase 3E is a project of AMSAT-DL and will operate with similar goals as AO-40. Additional information can be found in the P3-E section of AMSAT.org

PCSat2 Status: Launch May 2005

Uplink/Downlink 145.827 MHz FM 1200 Baud AFSK
Aux Uplink 435.250 MHz FM 9600 Baud AFSK
APRS Downlink 144.390 MHz FM (Region 2)
PSK-31 29 MHz (exact Frequency Unknown)

PCSat2 is not a satellite but rather it is a payload experiment that will be mounted externally on the International Space Station. It will use the same frequencies as PCSat2 but will include a PSK-31 experiment. To be launched on the Shuttle Discovery (<http://www2.jpl.nasa.gov/calendar/#0505>) For more information visit the PCSat2 Website.

Why not try a few contacts with - or listen to these birds? Remember the club now has a Satellite Working award.

A Radio Protection Scheme easily applied to any DC Power Supply

ZS6KR

Following serious damage to several expensive radios by some club members, the desire for better protection in case of power supply series transistors failing and thus applying some 18-25V DC to the radio, was put forward. Most power supplies appear only to be fused for over-current or electronically current limited, *but these are intended to protect itself and the load to some degree when experiencing an external load fault - not self-failure.*

The author picked up some useful tips on our PARC Monday 2m Technical Net as to where this was applied in the still famous Marchwood design of 1983 and investigated the possibility of hijacking the idea for universal use. The end result was a small PCB with six connections that can be built in to any existing power supply to act as a DC output over-voltage detector, mains circuit breaker and storage capacitor rapid discharger.

There is no messy intentional blowing of fuses applied and the original text correctly states that method is in any case to be too slow if you wish to blow the internal 20-25A fuse real fast. The circuit employed is sensible and needs no structural alteration.

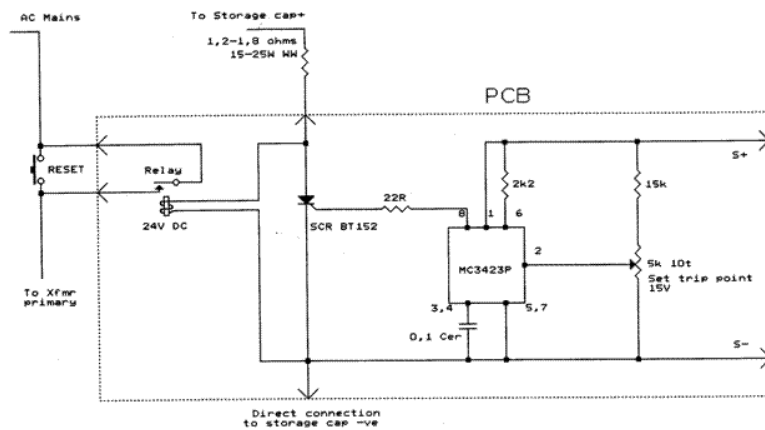

The IC is a Motorola device (still available), the SCR a 25A device and R is composed of two values rated at 10W each to make up the required maximum resistance for fast discharge. With typically 68000µF as a storage capacitance, the discharge time to 63% of the original capacitor voltage will be $\tau = RC = 1.5\text{ohms} \times 68000\mu\text{F} = 100\text{msec}$. Much before that the transformer primary relay has dropped out and energy replenishment cannot take place. The discharge to almost zero is another 150 msec or so but becomes irrelevant. The supply is then indefinitely off.

Once a trip has occurred, *a manual reset is not recommended* and the radio should be disconnected and the supply tested on open circuit. If the output is much higher than 13,8V, it needs repair and your radio should be intact.

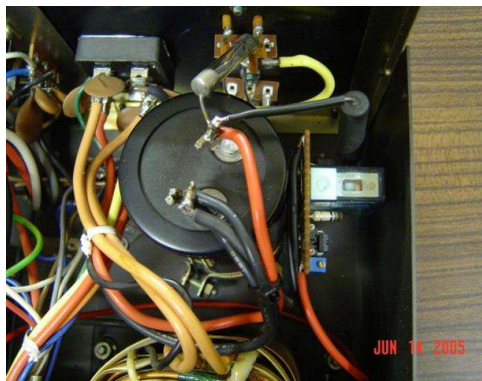

Installation examples
Placement in a Kenwood PS-30 and PS-53 supply.

The reset button can be placed on the front, inside, or rear panel.

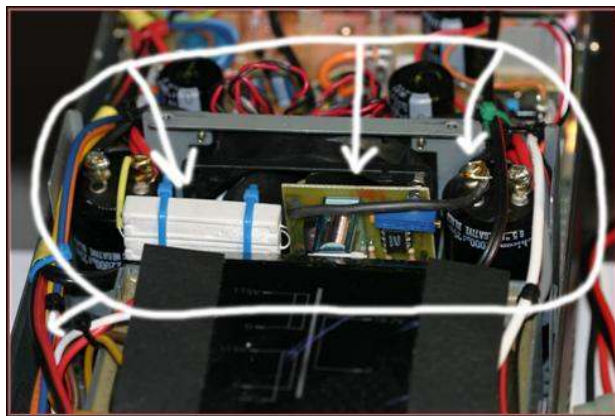
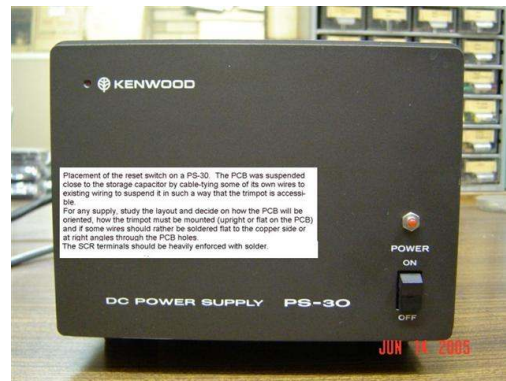

Stop press: Kits at R80 each should be available from the author at the time of publication. Bookings preferred.

65 Years ago...

PREVENT SABOTAGE

WITH THE NEW ELECTRONIC CAPACITY-ACTUATED ALARM RELAY

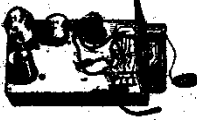

Ideal for trapping spies, fifth columnists, etc. Keeps snoopers away from valuables or important secret documents. The perfect alarm device since it protects by invisible electrostatic means.

When electrostatic field is disturbed by the approach of person or object, relay operates instantaneously. Relay may be connected to ring alarm bell or gong, turn lights on or off, start or stop motor, etc. Device may be used with counter to register number of persons or cars entering door or gateway or passing or approaching any point. Employs four tubes.

Complete and ready to operate, 110 volts **\$6.95**
A.C. or D.C. (less tubes)

Set of Four Matched Tubes\$1.95

ACCESSORIES: Single Tone Chime Announcer \$1;
Dual Tone Chime \$1.50; Electric Counter (0-99999)
metal case for 110 Volt A.C. \$5.95; 117 Volt A.C.
Fire Alarm Gong \$8.50; New Electronic Alarm
Sounding Device, audible for great distance, 110 Volt
A.C. or D.C., ready to use \$9.95.

77 years ago..

"The amateur is progressive....
He keeps his station abreast of science.
It is well-built and efficient.
His operating practice is above reproach."
(As formulated by Paul M. Segal, W9EAA in the year 1928)

ELEComics

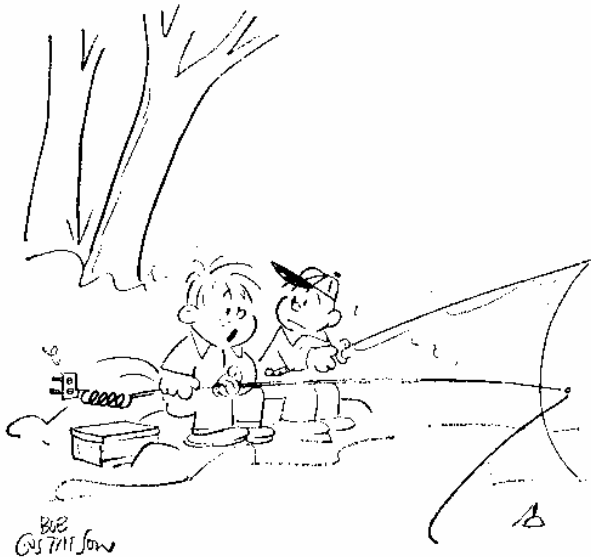

"I hope Pop doesn't turn on his car radio today!"

38 Years ago...

NEW! ASTRO-COM WRIST TRANSMITTER FM 88-108 MC \$13.95

- TRANSMIT TO ANY STANDARD FM RADIO
- WORKS INDOORS OR OUT
- SPRING LOADED ANTENNA
- BATTERY AVAILABLE ANYWHERE



NEW! ASTRO-COM \$13.95

- DURABLE WATCH STRAP
- HIGH-IMPACT PLASTIC
- IT'S FUN! IT'S EFFECTIVE! IT'S POWERFUL!
- NO LICENSE REQUIRED

© 1996 by Randy Glasbergen.
E-mail: randyg@norwich.net



"Hello, Bob? It's your father again.
I have another question about my new computer.
Can I tape a movie from cable TV then fax it from
my VCR to my CD-ROM then E-mail it to my
brother's cellular phone so he can make a
copy on his neighbor's camcorder?"